

SLURRY TANKERS



Container and basic equipment

CONTENT

- 4 Slurry tanker models
- 6 Containers
- 8 Running gears
- 12 Steering systems
- 14 Hitches
- 16 Tyres
- 18 Filling techniques:
Vacuum tankers and pump tankers



ALWAYS THE RIGHT SOLUTION

With garant application technology, you are guaranteed to have the right solution for your business. We have aligned our entire product range to fulfil individual customer wishes and to develop tailor-made products. Thanks to our modular system, you can put together exactly the equipment you need for your business.



OUR SLURRY TANKER MODELS

We offer you an extensive portfolio ranging from single-axle to four-axle slurry tankers and container sizes between 6 and 32 cubic metres. In addition, we adapt the container, the filling and spreading technology as well as other equipment options to your needs and requests. We want to make sure that you receive exactly the slurry technology that best meets your operational requirements.

Single-axle slurry tankers from 6 to 16 m³



Tandem slurry tankers from 8 to 21 m³



Tridem slurry tankers from 19 to 32 m³



Four-axle slurry tankers from 30 to 32 m³



CONTAINERS

garant slurry technology is robust and durable – an investment in the future. We only use high-quality steel containers from German manufacturers to ensure you achieve the best results even in the long term. Tailor-made solutions are our guiding principle. That's why we adapt all containers to your specific chassis and tyre size.

Corrosion protection

Every garant container offers reliable corrosion protection. You can choose between galvanising or a special internal coating.

The galvanising process, which has been tried and tested for decades, is particularly robust. The galvanised containers are coated with clear varnish on the outside as standard.

Alternatively, you can opt for a coloured exterior coating in combination with a high-quality Sika Permacor interior coating based on epoxy resin. The internal coating makes your container particularly resistant to aggressive substances and increases impact, shock and abrasion resistance. Thanks to the smooth structure of the exterior coating, the container is also much easier to clean.

By the way, you can freely choose the paint colour. You are guaranteed to draw attention to your business with your individually designed container.



Painted container



Galvanised container

Construction

Our containers are manufactured in a special low-profile design and thus offer you optimum driving comfort – both on the road and in the field. Another advantage is their low design in combination with the corresponding wheel housings, which allows all standard tyre sizes to be fitted to the slurry tanker. All tanks are equipped with surge walls in accordance with the DIN EN 707 standard.



Bolted baffles and Sika Permacor internal coating



RUNNING GEARS

We also rely on top quality for our running gears. To ensure a high level of operational safety, we only use original BPW axle units. In order to guarantee optimum driving safety, we adapt the BPW running gear individually to your vehicle while taking into account the permissible total weight, the tyres and the application.

Technical features:

- Square shaft up to 150 x 150 mm
- Brake drum up to 410 x 180 mm
- TÜV acceptance up to 60 km/h
- Preparation of the axles for tyre pressure control systems

Single-axle unit

Single-axle units are extremely resilient and optimally designed for use in agriculture. Depending on your requirements, we install unsprung or parabolic-suspension single-axle units.



Composite unit with parabolic suspension

The composite unit is characterised by very good slope stability. The load is evenly distributed. This ensures that the support load is maintained, even if you are using heavy spreading techniques.

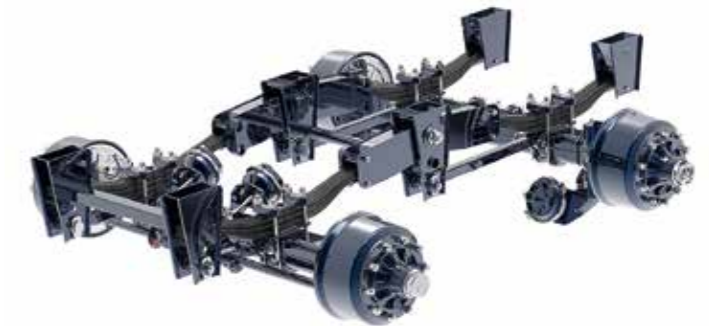

Boogie axle unit with parabolic suspension

The large spring balance between the axles makes the Boogie axle unit with parabolic suspension ideal for use in agriculture. Due to its good suspension properties, it is also ideal for road use.



Pneumatically sprung axle unit

The air suspension compensates most of the forces acting on the slurry tanker. This ensures optimum driving comfort. In addition, the air bellows of the first axle can be vented. This makes it possible to transfer additional drawbar load to the tractor.



Hydraulically sprung axle unit

Hydraulically suspended axles are suitable for vehicles with a high dead weight and special roll stability requirements.

These axle units ensure a very safe and at the same time comfortable ride. In addition, it is also possible to relieve the first axle, whereby additional drawbar load is transferred to the tractor.



Movable axis

If you use different spreading techniques, the height of the support loads can vary considerably. This pneumatically sprung axle can be moved hydraulically so that you always achieve an optimum drawbar load.



Drive axle

When more traction is needed off the road, the hydraulically driven drive axle is the right solution. This also makes it possible to use lighter tractors and to protect the soil by reducing slippage. The drive axle is powered by its own on-board hydraulics and delivers up to 100 kW of drive power.



Undercarriages options

	Single-axle Slurry tanker	Tandem-Slurry tanker	Tridem-Slurry tanker	Four-axle Slurry tanker
<i>Single-axle unit unsprung or with parabolic suspension</i>	x			
<i>Boogie axle unit with parabolic suspension</i>		x		
<i>Composite unit with parabolic suspension</i>		x	x	
<i>Pneumatically sprung axle unit</i>		x	x	x
<i>Hydraulically sprung axle unit</i>		x	x	x
<i>Movable axis</i>		x		
<i>Drive axle</i>	x	x	x	x

STEERING SYSTEMS

Steering axles offer numerous advantages. They improve manoeuvrability and directional stability and thus significantly reduce tyre wear and stress on the entire undercarriage. In addition, you save fuel with a steering axle, as the slurry tanker is much easier to pull. Less erasing also protects the soil and turf. In our garant slurry tankers, we only use high-quality Agrotorn axles of the latest generation made by BPW.

Hydraulic forced steering system

The hydraulic forced steering system is the easiest way to control one or more steering axles on the slurry tanker. It is of robust construction and has proven itself in practical use for decades. When you steer the towing vehicle, you also activate the cylinders between the towing vehicle and the trailer according to the curve radius. The amount of oil thus displaced controls the steering movement on the steering axle.

Thanks to direct power transmission, the hydraulic forced steering system enables a larger steering angle and narrower turning radii. This significantly improves driving comfort. Since the cylinders are mounted underneath the drawbar, no steering limiting collision protection is required. The cylinders can be easily and conveniently attached to the tractor.



Electronic forced steering ESS - ElectronicSteeringSystem

Our electronic steering system (ESS) is the electronic alternative to hydraulic forced steering and enables you to choose between different steering strategies. The steering linkage can be connected via a standardised knee-joint eyelet with 50 mm diameter. The central element is the drawbar sensor, which

measures changes in the steering angle. The steering axle is then controlled accordingly via a proportional valve.

Of course, you are always safe on the road with the ESS: critical states are automatically indicated to you via a terminal.



Electro-hydraulic steering system MSS - MultiSteeringSystem

The MultiSteeringSystem (MSS) electro-hydraulic steering system allows you to steer all the axles of the slurry tanker and choose between different steering strategies. When used on the road, the

in-track driving mode minimises tyre wear. When working in the field, you protect the soil by driving in lane or off-track (crab steering).





HITCHES

Whether top or bottom hitching, with or without drawbar suspension – we have the right hitch for every tractor and every system. To make your work even more efficient, we adapt the hitch of your slurry tanker individually to the existing tractor and to the permissible drawbar load.

Rigid top hitch

The top hitch for a flange towing eye or a K80 ball is suitable for slurry tankers with or without light spreading technology.



Rigid bottom hitch

The bottom hitch for a knee-joint eyelet with 80 mm diameter improves driving comfort and increases the ease of towing. In addition, higher drawbar loads can be achieved compared to the top hitch.



Bottom hitch with drawbar suspension

The bottom hitch with drawbar suspension offers the highest driving comfort. It can be adjusted to different coupling heights. This allows you to optimally adjust the slurry tanker's inclination to any situation during filling and emptying.



Hitch options

	Single-axle slurry tanker	Tandem-slurry tanker	Tridem-slurry tanker	Four-axle slurry tanker
<i>Rigid top hitch</i>	x	x		
<i>Rigid bottom hitch</i>	x	x	x	
<i>Drawbar suspension</i>	x	x	x	x



TYRES

Tyres for every operating situation. Type, tread pattern and size must be perfectly matched to the application. Whether it is a simple water barrel with 385 road tyres or a “bog racer” – we supply you with the right tyre for all working conditions and every type of ground.

Not all tyres are the same

Our range includes both radial and diagonal tyres. You can choose between diameters from 22.5 to 42 inches and widths from 385 to 1,050 millimetres. Of course, we rely exclusively on well-known manufacturers such as Vredestein or Trelleborg.



Mitas Agriterra 800/65R32



BKT Agrimax Fortis 800/70R38



FILLING TECHNIQUES

No matter whether you are using a vacuum tanker or a pump tanker – garant provides you with the filling technology that suits you. Whether you want to speed up filling, operate large working widths or precisely dose the application quantities – we have the optimum solution for your needs and requirements.

Vacuum tankers

Our vacuum tankers are easy to operate and convince with a long service life as well as an excellent price-performance ratio. We equip the vehicles exclusively with quality compressors from the manufacturer Jurop. In addition, maintenance work can be carried out easily and cost-effectively.

The special features of the DL series are the oil-free operation, the continuous operation and the extremely low noise level.

In addition to our proven, simple vacuum technology, we also offer the vacuum TopFlow technology. This offers improved maintainability and accessibility, as well as the options for a flow meter, a pressure accelerator and quantity measurement. A jam slider can also be installed.

Compressors options

Compressor type	air output
PN 45	5,300 l/min
PN 84	9,000 l/min
PN 106	11,000 l/min
PN 124	12,400 l/min
PN 142	14,200 l/min
PN 155	15,200 l/min
DL125	12,400 l/min
DL 150	15,000 l/min
DL 180	17,600 l/min

How the vacuum tanker works

A vacuum tanker is filled and emptied by means of underpressure and overpressure. If the tanker is to be filled, a vacuum compressor generates a vacuum. As a result, the liquid manure flows into the tank. During application, the compressor generates an overpressure which actively pushes the liquid manure out of the tank.



“Filling“ vacuum slurry tanker

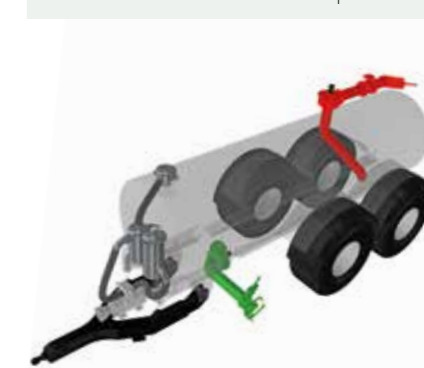

“Filling“ Vacuum TopFlow

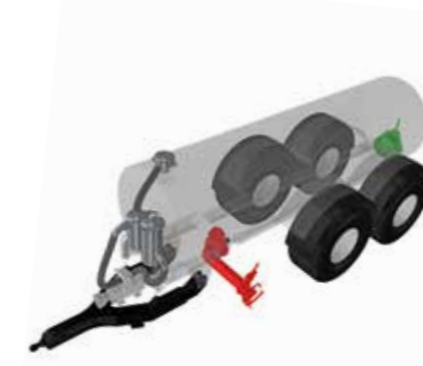

“Spreading“ vacuum slurry tanker

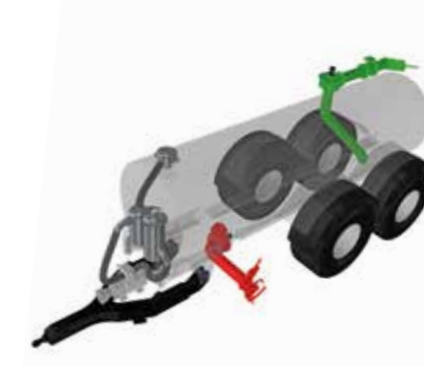

“Spreading“ Vacuum TopFlow

Power boost technology for vacuum slurry tankers

The unbeatable advantage of the Power Boost technology: You can use it to fill your slurry tanker quickly and completely. At the same time, the agitator function ensures that no solids sink and thus prevents blockages.

Another plus: The Power Boost technology enables large working widths of up to 27 metres. Compared to a pump tanker, wear and tear is also significantly lower.

How the Power Boost technology for vacuum slurry tankers works

The garant Power Boost technology is a combination of a vacuum and a centrifugal pump system. The tank is filled and emptied with the aid of a centrifugal pump driven by a power take-off shaft. The vacuum compressor is hydraulically driven. Unlike the normal vacuum tanker, the compressor in this model only serves to suck the slurry up to the centrifugal pump.



Power-Boost tanker

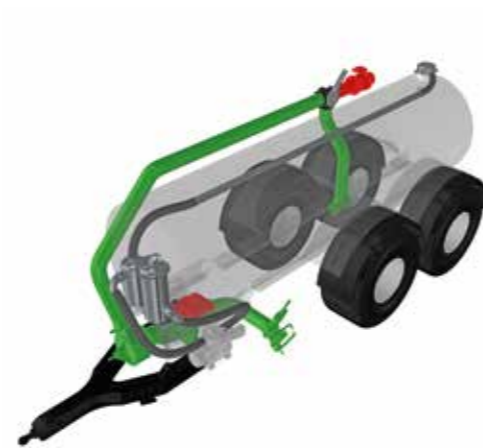

“Filling“ Power-Boost-Technique

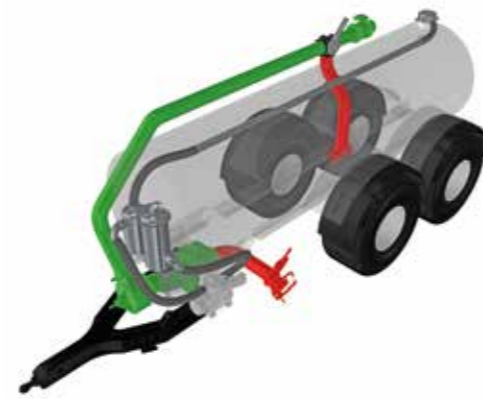

“Spreading“ Power-Boost-Technique

Pump tankers

Pump tankers offer you maximum efficiency, especially for large suction depths and difficult suction conditions. When spreading, they generate a high and constant pressure, which is also sufficient for spreading techniques with large working widths. In addition, you can easily and accurately dose the application rate with a pump tanker.

All our garant slurry tankers are equipped with quality pumps from renowned manufacturers. In addition to rotary lobe pumps from Vogelsang, our range also includes eccentric screw pumps made by Wangen.

How the pump tanker with rotary lobe pump works

The suction effect of the rotary lobe pump is created by a pair of pistons that rotate evenly inside the pump. The slurry flows into the tank via a pressure line located on top of the tank. A floater in the rear wall of the tanker reliably measures the fill level and activates an automatic shut-off as soon as the maximum fill level is reached. A pump sump as well as a „standing“ suction line in the tanker ensure that the tank is completely and optimally emptied during discharge. With the help of two three-way sliders, you can conveniently switch between the three functions „filling“, „spreading“ and „stirring“



Rotary lobe pump for the TopFlow system

Pump tanker with direct drive

Our pump tankers with direct drive are optionally equipped with a 4, 6 or 9 cbm rotary lobe pump. In addition, an active or passive application rate control can be selected.

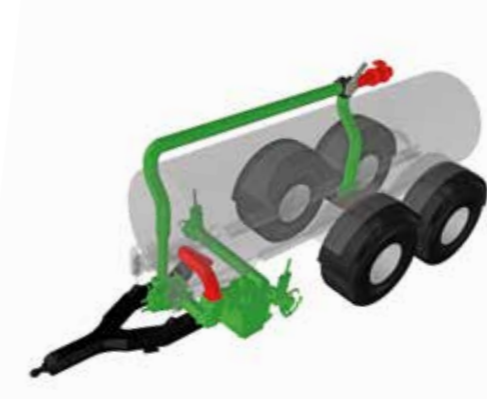

“Filling“ pump tanker with direct drive

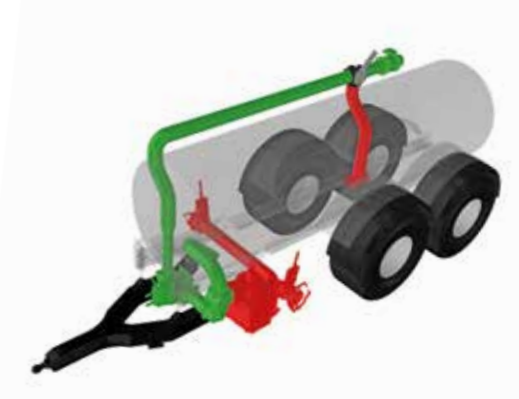

“Spreading“ pump tanker with direct drive

TopFlow and TwinFlow

The garant pump tankers with hydraulic pump drive can be equipped with a 6, 9, 12 or 14 cbm rotary lobe pump. Our garant on-board hydraulics drive the rotary lobe pump via its own power unit and make it independent of the speeds of the tractor PTO shaft.

For hydraulically driven rotary lobe pumps with a capacity of up to 10,000 litres, our TopFlow system significantly increases the working comfort and maintainability of the pump.

Here, a cutter unit with stone catcher is installed. From a pump capacity of 10,000 litres, a single cutter unit with stone trap limits the performance potential of the pump.

That's why we install two cutterbar units with one or two suction and pressure lines each in our garant TwinFlow system. This doubling allows the full performance potential of the rotary lobe pump of up to 14,000 litres per minute to be exploited.

Eccentric screw pumps

Eccentric screw pumps are characterised by a good price-performance ratio and low life cycle costs. The robust technology is insensitive to foreign bodies and offers high operational reliability.

Our pump tankers with eccentric screw pump are available in two versions: Eco and TopFlow. The Eco version combines our proven, internal piping system in NW 150 with the option of a 4 or 6 cbm pump. For increased requirements, our TopFlow system is equipped with a powerful pipe run in NW 200 and a 4 or 6 cbm pump. With the TopFlow system, you have the option of equipping your slurry tanker with a flow meter for active or passive application rate control as well as an NIR sensor for the future.

How the pump tanker with eccentric screw pump works

The eccentric screw pump generates its suction effect by means of a rotor that rotates inside a stator, thus creating a negative pressure. The slurry flows into the tank through a pressure pipe. With the help of sliders, you can easily switch between the three functions „filling“, „spreading“ and „stirring“.



Wangen eccentric screw pump GL 65 F 140.0

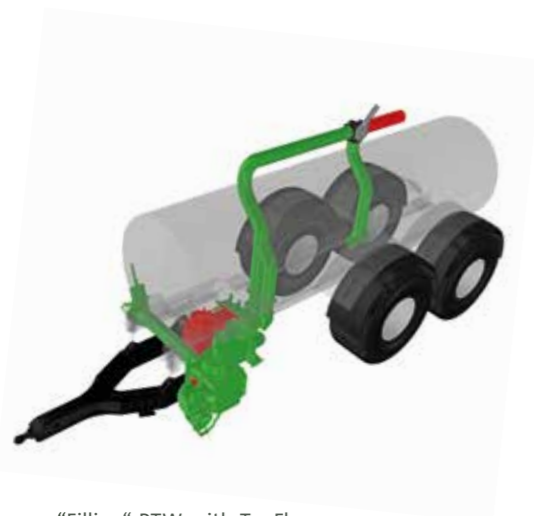

“Filling“ PTW with TopFlow

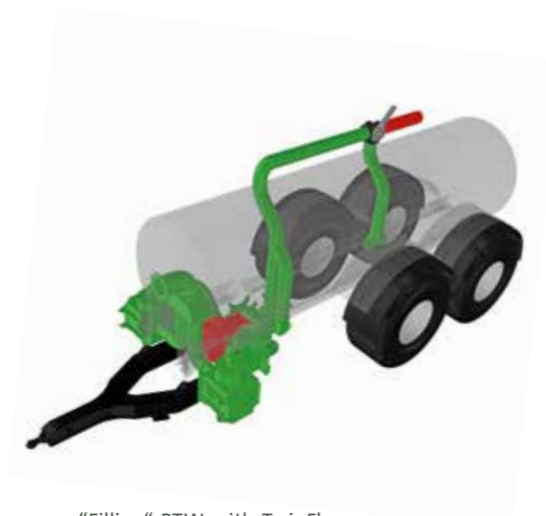

“Filling“ PTW with TwinFlow

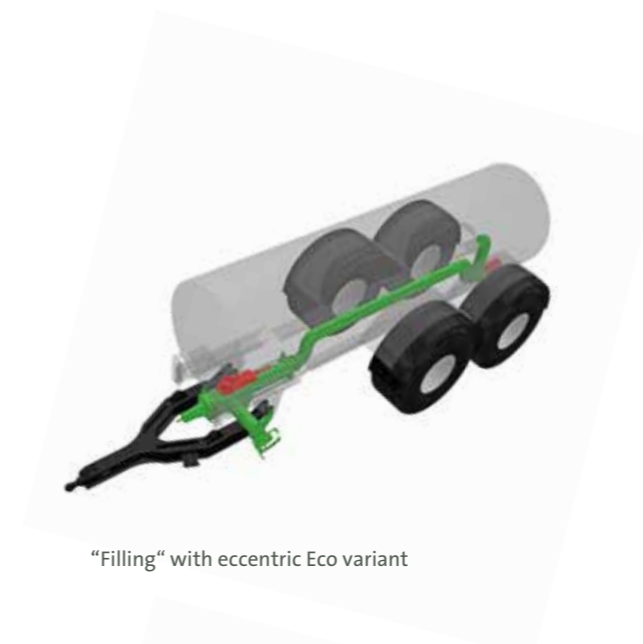

“Filling“ with eccentric Eco variant



“Filling“ with Excenter TopFlow

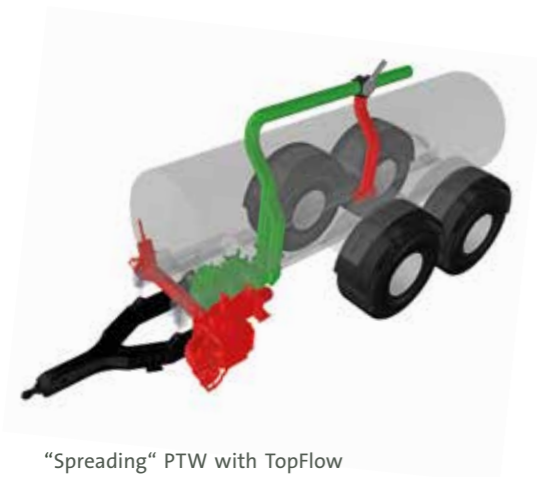

“Spreading“ PTW with TopFlow

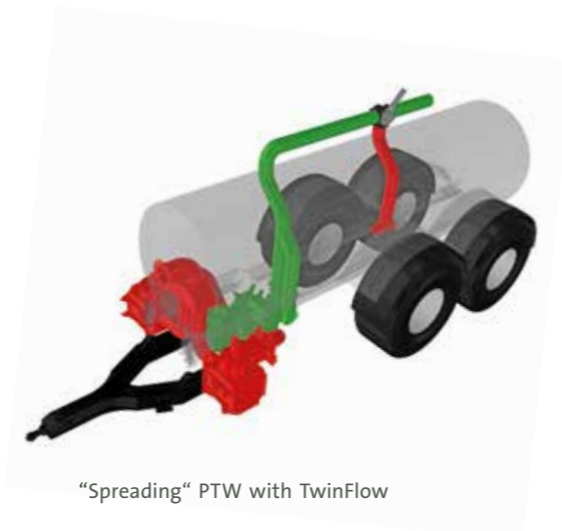

“Spreading“ PTW with TwinFlow

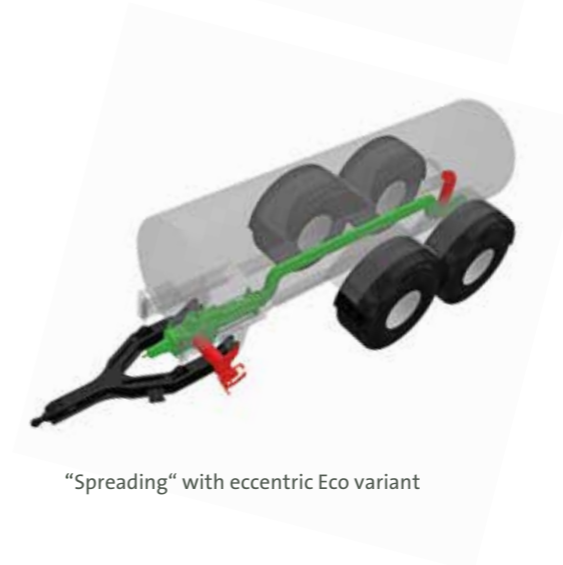

“Spreading“ with eccentric Eco variant

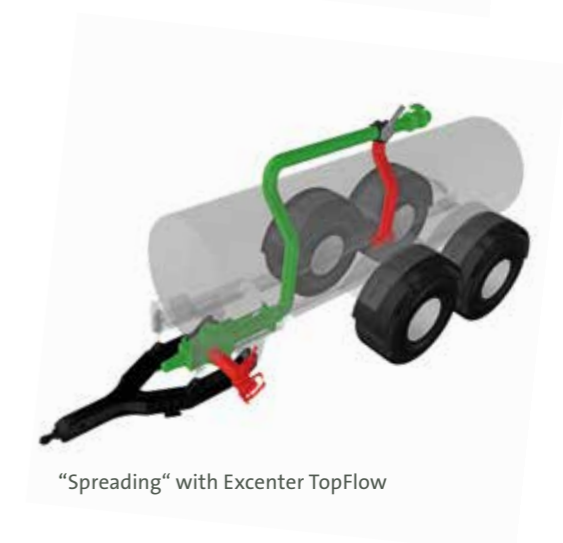

“Spreading“ with Excenter TopFlow

For healthy growth

This has been our guiding principle in the five decades that we have been developing and producing individual slurry technology for agriculture under the “garant” brand. With a broad product portfolio, our family-run company based in Rieste, Lower Saxony, is the German market leader for liquid manure technology. Our slurry tankers encompass sophisticated technology that is tailored to your needs.

Every vehicle is different

Thanks to the modular construction principle, you can put together exactly the equipment for your slurry tanker that best meets your requirements. This brochure provides an overview of our slurry tankers and the options available for the basic equipment. All additional options are presented in the brochure “Additional equipment“. Information on spreading technology and on our operator terminals can be found in the brochures of the same name.

